

PRELIMINARY

Notice: This is not a final specification
Some parametric are subject to change.

INA6006AC1

FOR LOW FREQUENCY AMPLIFY APPLICATION
SILICON PNP EPITAXIAL TYPE

DESCRIPTION

INA6006AC1 is a silicon PNP transistor.
It is designed with high voltage.

FEATURE

- Small package for easy mounting.
- High voltage $V_{CEO} = -150V$
- Low voltage $V_{CE(sat)} = -0.5V(MAX)$
- Complementary : INC6006AC1

APPLICATION

High voltage switching.

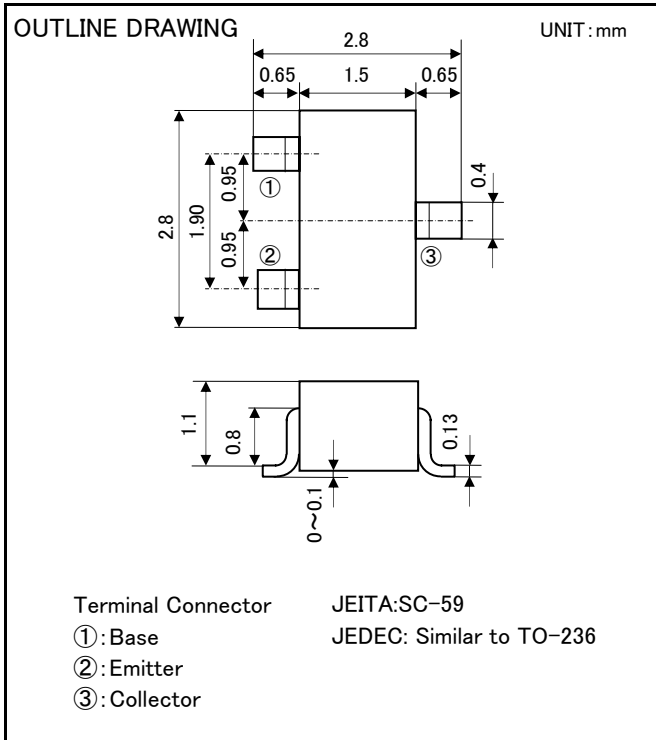

MAXIMUM RATING (Ta=25°C)

SYMBOL	PARAMETER	RATING	UNIT
V_{CBO}	Collector to Base voltage	-160	V
V_{EBO}	Emitter to Base voltage	-5	V
V_{CEO}	Collector to Emitter voltage	-150	V
I_{CM}	Peak collector current	-200	mA
I_C	Collector current	-100	mA
P_C	Collector dissipation(Ta=25°C)	200	mW
		500(*)	
T_j	Junction temperature	+150	°C
T_{stg}	Storage temperature	-55~+150	°C

*Mounted on glass epoxy board(46mm × 19mm × 1mm)

MARKING

Type Name

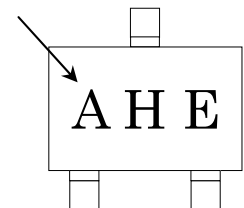

ELECTRICAL CHARACTERISTICS (Ta=25°C)

SYMBOL	PARAMETER	TEST CONDITIONS	LIMITS			UNIT
			MIN	TYP	MAX	
$V_{(BR)CBO}$	C to B break down voltage	$I_C = -100 \mu A, I_E = 0mA$	-160	-	-	V
$V_{(BR)EBO}$	E to B break down voltage	$I_E = -10 \mu A, I_C = 0mA$	-5	-	-	V
$V_{(BR)CEO}$	C to E break down voltage	$I_C = -1mA, R_{BE} = \infty$	-150	-	-	V
I_{CBO}	Collector cut off current	$V_{CB} = -120V, I_E = 0mA$	-	-	-100	nA
I_{EBO}	Emitter cut off current	$V_{EB} = -3V, I_C = 0mA$	-	-	-100	nA
hFE1	DC forward current gain1	$V_{CE} = -5V, I_C = -1mA$	45	-	-	-
hFE2	DC forward current gain2	$V_{CE} = -5V, I_C = -10mA$	90	-	270	-
hFE3	DC forward current gain3	$V_{CE} = -5V, I_C = -50mA$	45	-	-	-
$V_{CE(sat)1}$	C to E saturation voltage1	$I_C = -10mA, I_B = -1mA$	-	-	-0.2	V
$V_{CE(sat)2}$	C to E saturation voltage2	$I_C = -50mA, I_B = -5mA$	-	-	-0.5	V
$V_{BE(sat)1}$	B to E saturation voltage1	$I_C = -10mA, I_B = -1mA$	-	-	-1.0	V
$V_{BE(sat)2}$	B to E saturation voltage2	$I_C = -50mA, I_B = -5mA$	-	-	-1.0	V
$V_{BE(on)}$	B to E on voltage	$V_{CE} = -5V, I_C = -10mA$	-	-	-0.77	V
fT	Gain bandwidth product	$V_{CE} = -10V, I_E = 10mA$	100	-	300	MHz
Cob	Collector output capacitance	$V_{CB} = -10V, I_E = 0mA, f = 1MHz$	-	2.8	6	pF

PRELIMINARY

Notice: This is not a final specification
Some parametric are subject to change.

INA6006AC1

FOR LOW FREQUENCY AMPLIFY APPLICATION
SILICON PNP EPITAXIAL TYPE

TYPICAL CHARACTERISTICS

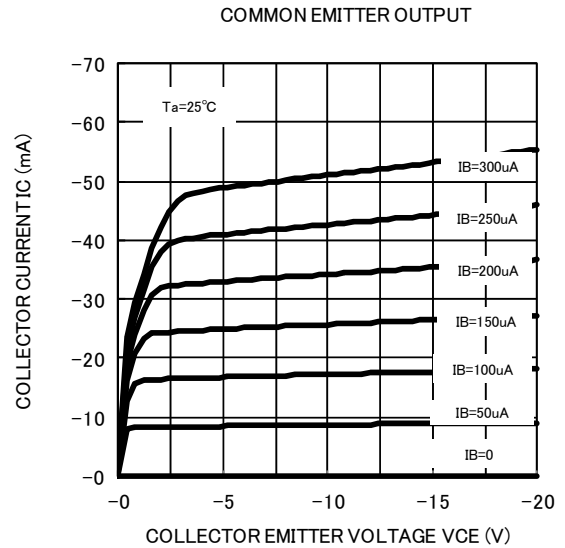
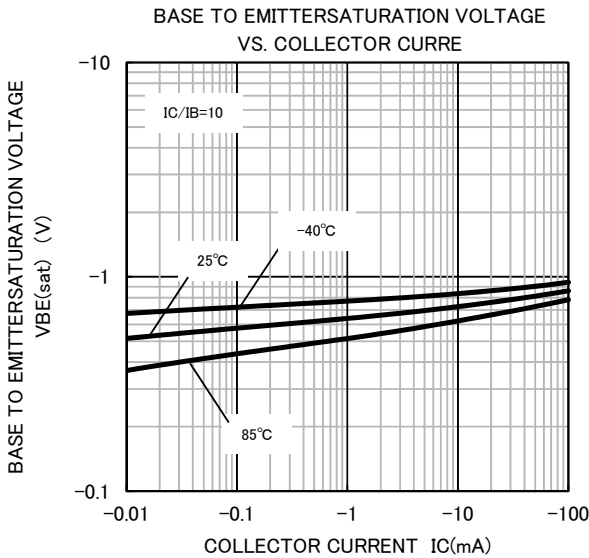
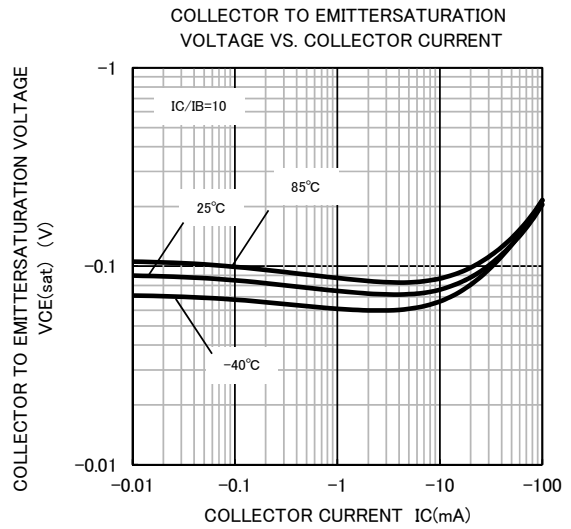
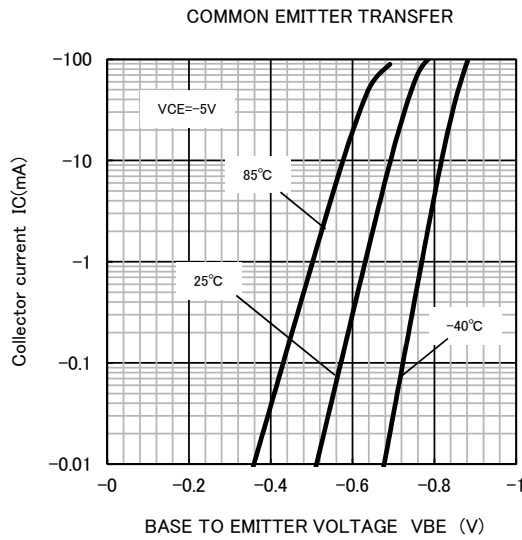
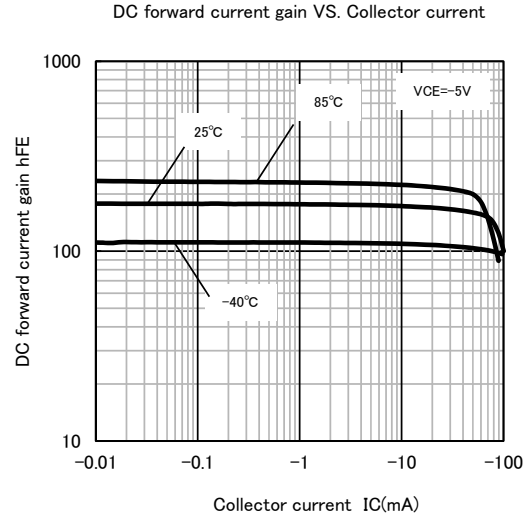
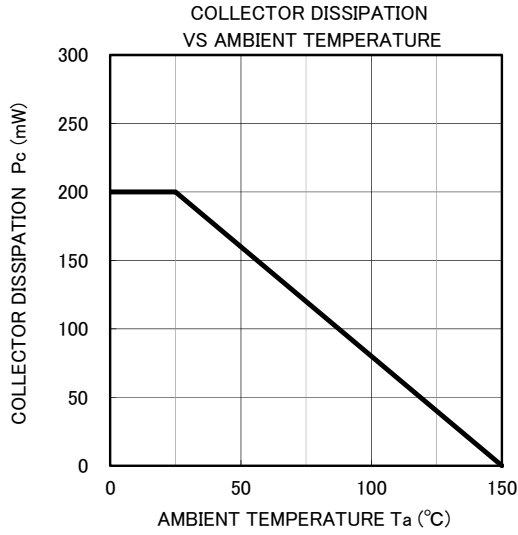

PRELIMINARY

Notice: This is not a final specification
Some parametric are subject to change.

INA6006AC1

FOR LOW FREQUENCY AMPLIFY APPLICATION
SILICON PNP EPITAXIAL TYPE

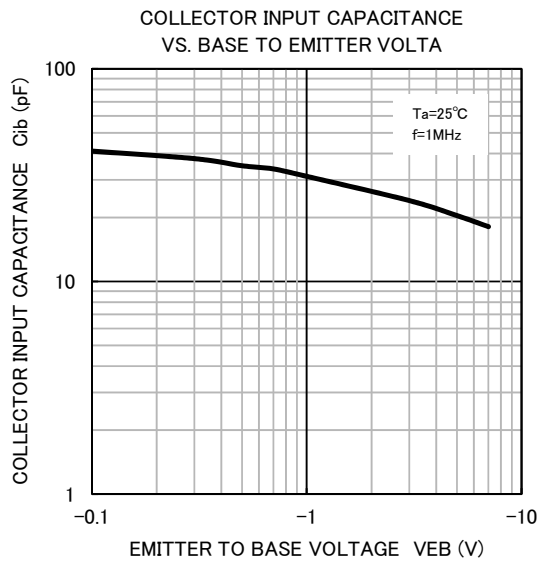
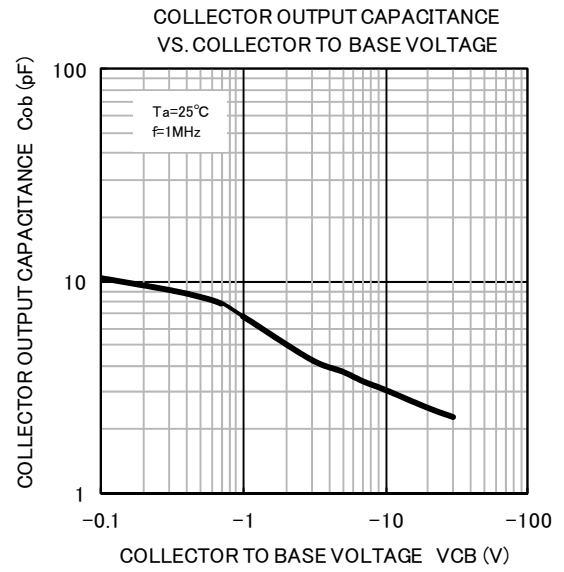
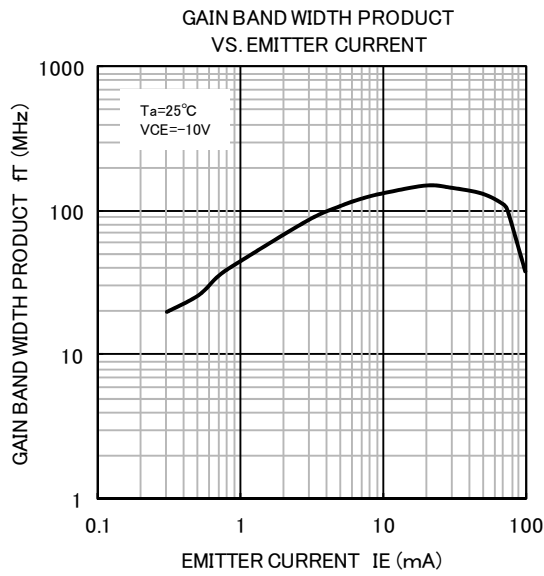



6-41 Tsukuba, Isahaya, Nagasaki, 854-0065 Japan

Keep safety first in your circuit designs!

•ISAHAYA Electronics Corporation puts the maximum effort into making semiconductor products better and more reliable, but there is always the possibility that trouble may occur with them. Trouble with semiconductors may lead to personal injury, fire or property damage. Remember to give due consideration to safety when making your circuit designs, with appropriate measures such as (1) placement of substitutive, auxiliary, (2) use of non-flammable material or (3) prevention against any malfunction or mishap.

Notes regarding these materials

- These materials are intended as a reference to our customers in the selection of the ISAHAYA products best suited to the customer's application; they don't convey any license under any intellectual property rights, or any other rights, belonging ISAHAYA or third party.
- ISAHAYA Electronics Corporation assumes no responsibility for any damage, or infringement of any third party's rights, originating in the use of any product data, diagrams, charts or circuit application examples contained in these materials.
- All information contained in these materials, including product data, diagrams and charts, represent information on products at the time of publication of these materials, and are subject to change by ISAHAYA Electronics Corporation without notice due to product improvements or other reasons. It is therefore recommended that customers contact ISAHAYA Electronics Corporation or an authorized ISAHAYA products distributor for the latest product information before purchasing product listed herein.
- ISAHAYA Electronics Corporation products are not designed or manufactured for use in a device or system that is used under circumstances in which human life is potentially at stake. Please contact ISAHAYA electronics corporation or an authorized ISAHAYA products distributor when considering the use of a product contained herein for any specific purposes, such as apparatus or systems for transportation, vehicular, medical, aerospace, nuclear, or undersea repeater use.
- The prior written approval of ISAHAYA Electronics Corporation is necessary to reprint or reproduce in whole or in part these materials.
- If these products or technologies are subject to the Japanese export control restrictions, they must be exported under a license from the Japanese government and cannot be imported into a country other than the approved destination. Any diversion or re-export contrary to the export control laws and regulations of Japan and/or the country of destination is prohibited.
- Please contact ISAHAYA Electronics Corporation or authorized ISAHAYA products distributor for further details on these materials or the products contained therein.